

TECHNICAL SPECIFICATION / TECHNISCHE BESCHREIBUNG / DESCRIPTION TECHNIQUE

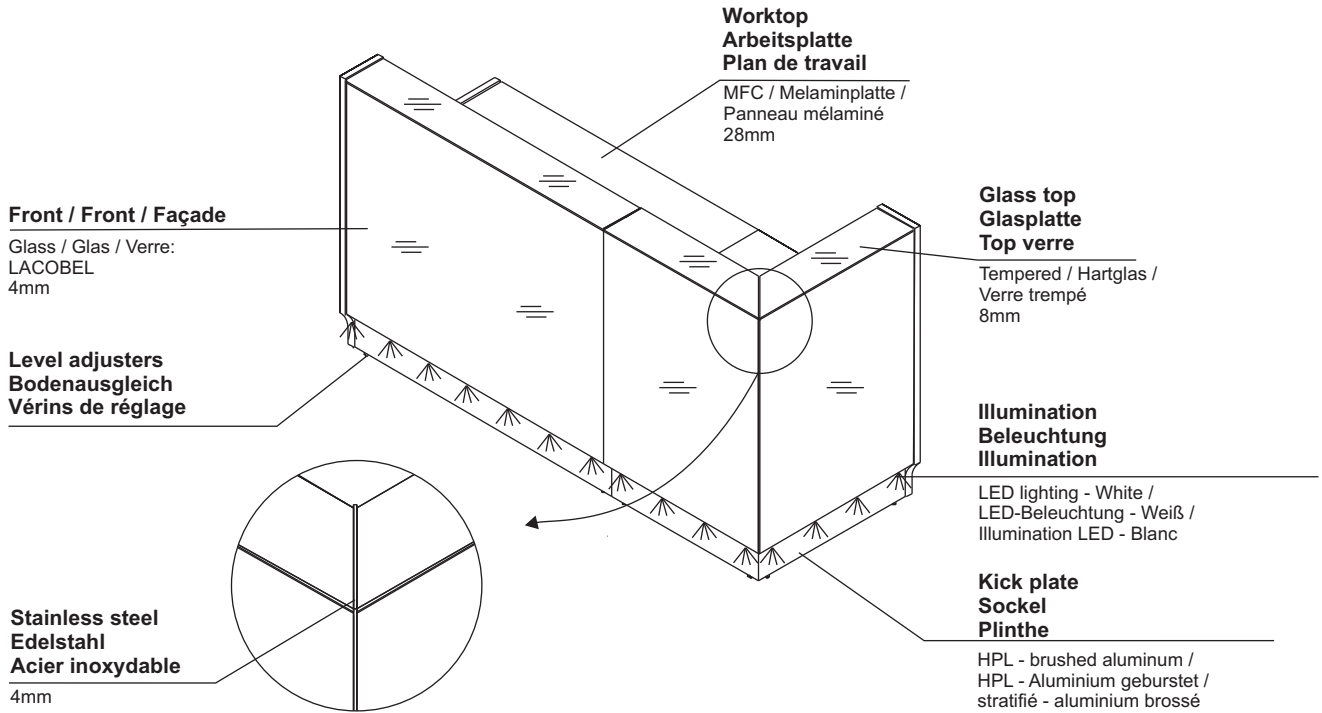

**Worktop with optional
monitor shelf (136 euro)
Arbeitsplatte mit
Monitorboden (als Option)
Plan de travail avec découpe
et support pour l'écran en option**

MFC / Melaminplatte /
Panneau mélaminé
28mm

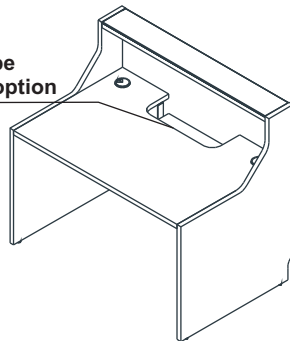

**Side panel
Wangenfuß
Pied latéral**

MFC / Melaminplatte /
Panneau mélaminé
28mm

**Cable-way
Kabeldurchlass
Obturateur**

∅ 80mm

**Supporting leg where worktops connect
Stützfuß
Nécessaire sur la jonction des banquettes**

NL41 required on all connections of receptions /
NL41 Stützfuß zusätzlich zur Verbindung der Thekenelemente bestellen /
NL41 nécessaire sur la connexion des banquettes

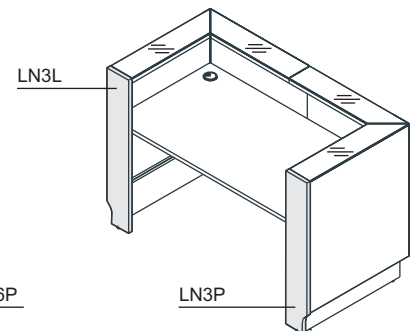
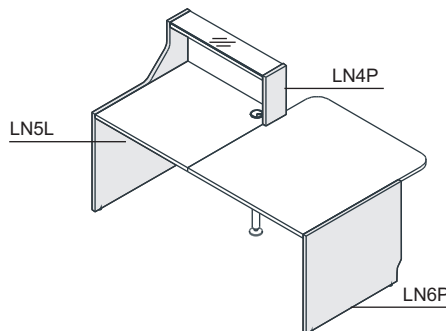
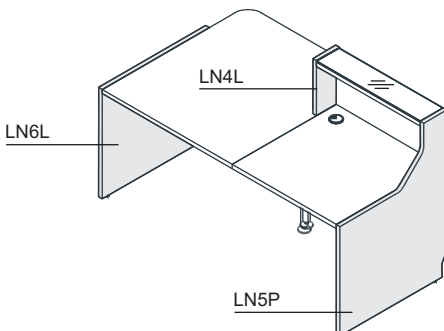
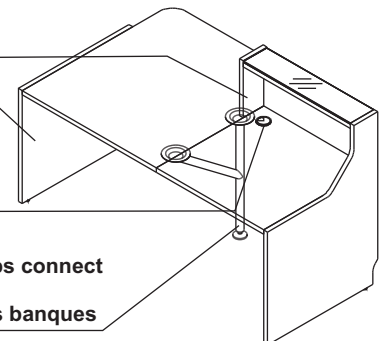

TECHNICAL SPECIFICATION / TECHNISCHE BESCHREIBUNG / DESCRIPTION TECHNIQUE

**Top
Oberplatte
Plateau**

MFC / Melaminplatte /
Panneau mélaminé
12mm

**Body
Korpus
Corps**

MFC / Melaminplatte /
Panneau mélaminé
18mm

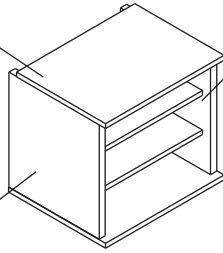

**Shelf
Boden
Plateau**

MFC / Melaminplatte /
Panneau mélaminé
12mm

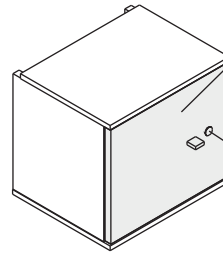

**Door
Tür
Porte**

MFC / Melaminplatte /
Panneau mélaminé
18mm

Lock / Verschluss / Serrure

- central lock
- Zentralverschluss
- serrure centralisée

DIMENSIONS / ABMESSUNG / DIMENSIONS

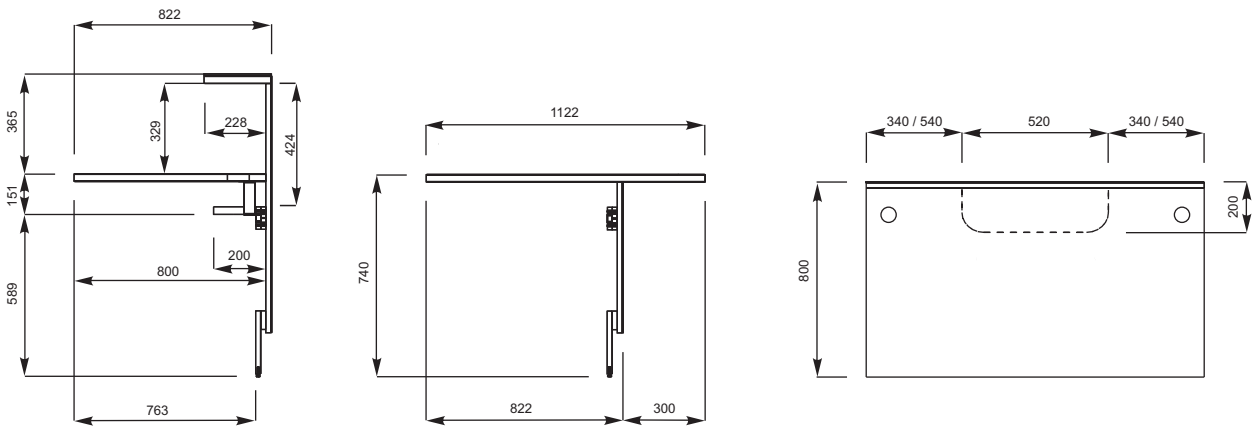

FINISHES / FARBEN / FINITIONS

67-WHITE PASTEL WEIß PASTELL BLANC PASTEL	TEMPERED GLASS, WHITE HARTGLAS, WEIß VERRE TREMPÉ, BLANC			15 METAL, HIGH GLOSS WHITE METALL, WEIß GLANZ METAL, BLANC BRILLANT		
08-BLACK SCHWARZ NOIR	TEMPERED GLASS, BLACK HARTGLAS, SCHWARZ VERRE TREMPÉ, NOIR			08 METAL, BLACK METALL, SCHWARZ METAL, NOIR		
26-ALUMINIUM SATINATO ALUMINIUM SATINATO ALUMINIUM SATINE	TEMPERED GLASS, SILVER HARTGLAS, SILBERN VERRE TREMPÉ, ARGENT			15 METAL, HIGH GLOSS WHITE METALL, WEIß GLANZ METAL, BLANC BRILLANT		
44-BLACK SCHWARZ NOIR	44: 0WHITE WEIß BLANC	124-SILVER SILBERN ARGENT	134-DARK TURQUOISE TÜRKIS TURQUOISE	135-YELLOW GELB JAUNE	136-FUCHSIA PINK ROSE	
26-ALUMINIUM SATINATO ALUMINIUM SATINATO ALUMINIUM SATINE	67-WHITE PASTEL WEIß PASTELL BLANC PASTEL	08-BLACK SCHWARZ NOIR				
30-WHITE WEIß BLANC	08-BLACK SCHWARZ NOIR	09-ALUMINIUM ALUMINIUM ALUMINIUM		Tambour Jalousie Rideaux		

RECEPTION DESK SYSTEMS / EMPFANGSTHEKEN-SYSTEME / CONFIGURATIONS DES BANQUES

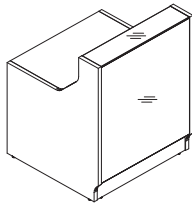

LN5P+LN12+LNB13+LN5L

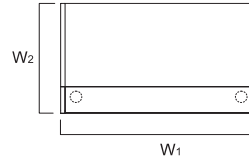
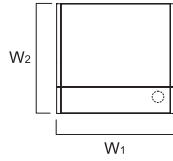

INDEX SYMBOL	DIMENSIONS / ABMESSUNGEN [mm]					GBP				COMMENTS / BEMERKUNGEN / REMARQUES
	W ₁	W ₂	D ₁	D ₂	H		kg	m ³	pcs	
08 LIN08 08	856	824	-	-	1105	1 054,-	70.5	0.350	7	
12 LIN13 13	1256	824	-	-	1105	1 377,-	91.5	0.488	8	

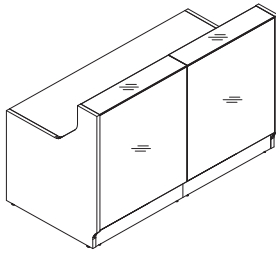

LN5P+LN08+LN08+LNB15+LN5L

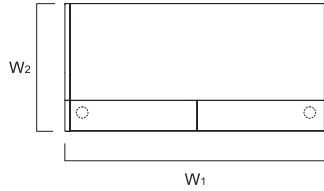

INDEX SYMBOL	DIMENSIONS / ABMESSUNGEN [mm]					GBP				COMMENTS / BEMERKUNGEN / REMARQUES
	W ₁	W ₂	D ₁	D ₂	H		kg	m ³	pcs	
LIN15 15	1656	824	-	-	1105	1 930,-	112.0	0.637	12	

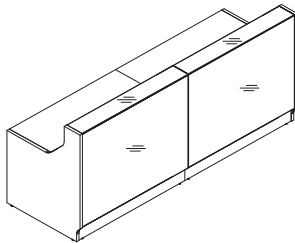

LN5P+LN12+LNB13+NL41+LN12+LNB13+LN5L

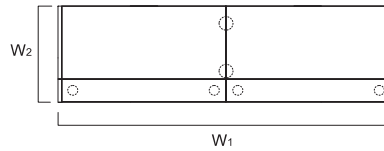

INDEX SYMBOL	DIMENSIONS / ABMESSUNGEN [mm]					GBP				COMMENTS / BEMERKUNGEN / REMARQUES
	W ₁	W ₂	D ₁	D ₂	H		kg	m ³	pcs	
13 LIN25 13	2456	824	-	-	1105	2 625,-	160.0	0.979	16	

DESCRIPTION / LEGENDE / LÉGENDE:

net weight / Nettogewicht / poids net

volume / Volumen / le volume

number of packages / Stückzahl der Pakete / nombre de colis

RECEPTION DESK SYSTEMS / EMPFANGSTHEKEN-SYSTEME / CONFIGURATIONS DES BANQUES

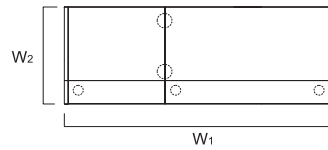
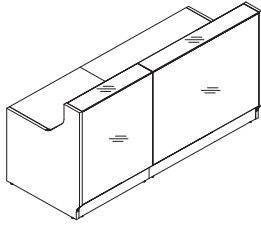

LN5P+LN08+LNB08+NL41+LN12+LNB13+LN5L

INDEX SYMBOL	DIMENSIONS / ABMESSUNGEN [mm]					GBP	kg	m3	pcs	COMMENTS / BEMERKUNGEN / REMARQUES
	W1	W2	D1	D2	H					
08 LIN20 13	2056	824	-	-	1105	2 363,-	136.0	0.835	14	

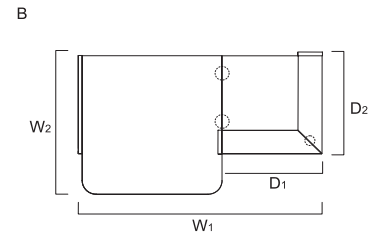
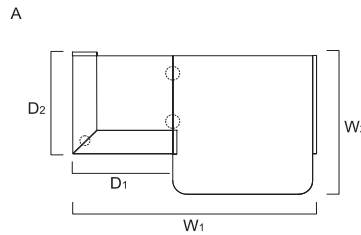
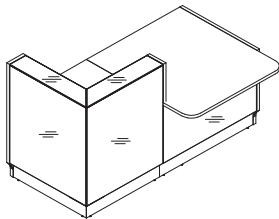

A: LN3P+LN91+LNB08+NL41+LN4L+LNU11+LN6L
 B: LN6P+LNU11+NL41+LN4P+LNB08+LN91+LN3L

INDEX SYMBOL		DIMENSIONS / ABMESSUNGEN [mm]					GBP	kg	m3	pcs	COMMENTS / BEMERKUNGEN / REMARQUES
A	B	W1	W2	D1	D2	H					
LIN29L 15	LIN29P 15	1850	1150	822	850	1105	2 302,-	149.5	1.305	13	

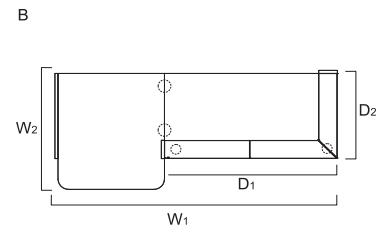
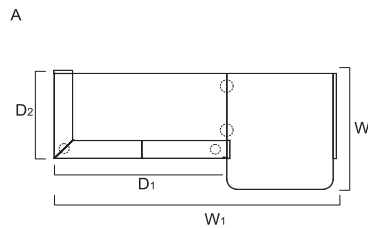
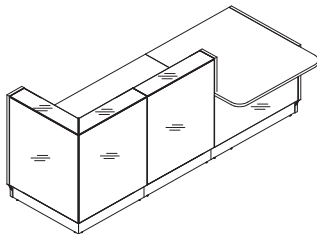

A: LN3P+LN91+LNB15+LN08+NL41+LN4L+LNU11+LN6L
 B: LN6P+LNU11+NL41+LN4P+LN08+LNB15+LN91+LN3L

INDEX SYMBOL		DIMENSIONS / ABMESSUNGEN [mm]					GBP	kg	m3	pcs	COMMENTS / BEMERKUNGEN / REMARQUES
A	B	W1	W2	D1	D2	H					
LIN35L	LIN35P	2650	1150	-	-	1105	3 177,-	191.0	1.593	18	

DESCRIPTION / LEGENDE / LÉGENDE:

net weight / Nettogewicht / poids net

volume / Volumen / le volume

number of packages / Stückzahl der Pakete / nombre de colis

RECEPTION DESK SYSTEMS / EMPFANGSTHEKEN-SYSTEME / CONFIGURATIONS DES BANQUES

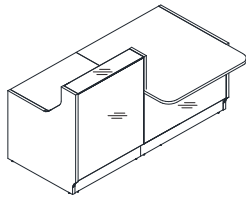

A

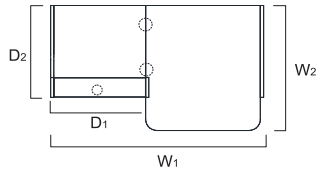

B

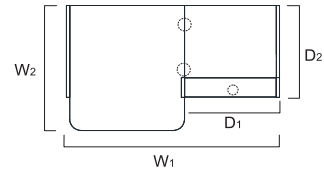

A: LN5P+LN08+LNB08+NL41+LN4L+LNU11+LN6L
 B: LN6P+LNU11+NL41+LN4P+LN08+LNB08+LN5L

INDEX SYMBOL		DIMENSIONS / ABMESSUNGEN [mm]					GBP	kg	m3	pcs	COMMENTS / BEMERKUNGEN / REMARQUES
A	B	W ₁	W ₂	D ₁	D ₂	H					
⁰⁸ LIN33L	⁰⁸ LIN33P	1856	1122	828	824	1105	1 885,-	97.5	0.506	13	

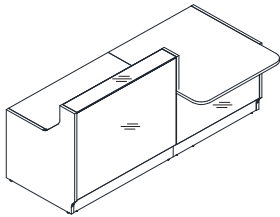

A

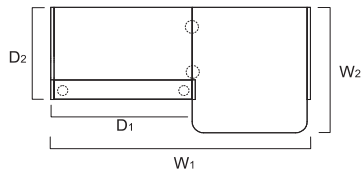

B

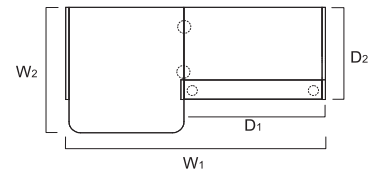

A: LN5P+LN12+LNB13+NL41+LN4L+LNU11+LN6L
 B: LN6P+LNU11+NL41+LN4P+LN12+LNB13+LN5L

INDEX SYMBOL		DIMENSIONS / ABMESSUNGEN [mm]					GBP	kg	m3	pcs	COMMENTS / BEMERKUNGEN / REMARQUES
A	B	W ₁	W ₂	D ₁	D ₂	H					
¹³ LIN34L	¹³ LIN34P	2256	1122	1228	824	1105	2 208,-	126.5	0.710	14	

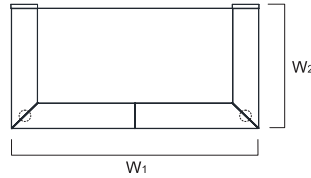
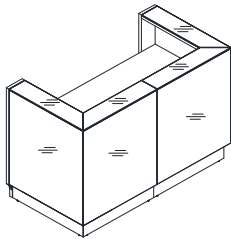

LN3P+LN91+LNB15+LN91+LN3L

INDEX SYMBOL		DIMENSIONS / ABMESSUNGEN [mm]					GBP	kg	m3	pcs	COMMENTS / BEMERKUNGEN / REMARQUES
		W ₁	W ₂	D ₁	D ₂	H					
LIN36		¹⁵ 1644	850	-	-	1105	2 763,-	200.0	2.105	12	

DESCRIPTION / LEGENDE / LÉGENDE:

net weight / Nettogewicht / poids net

volume / Volumen / le volume

number of packages / Stückzahl der Pakete / nombre de colis

RECEPTION DESK SYSTEMS / EMPFANGSTHEKEN-SYSTEME / CONFIGURATIONS DES BANQUES

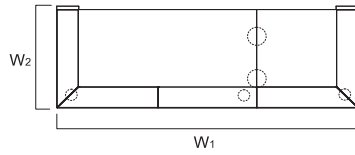
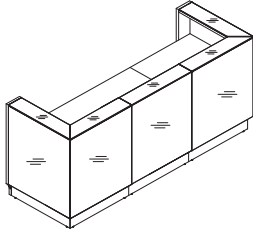

2xLN91+LN08+LNB15+LNB08+LN3L+LN3P+NL41

INDEX SYMBOL	DIMENSIONS / ABMESSUNGEN [mm]					GBP				COMMENTS / BEMERKUNGEN / REMARQUES
	W ₁	W ₂	D ₁	D ₂	H		kg	m ³	pcs	
15 LIN42 08	2444	850	-	-	1105	3 687,-	243.0	2.445	15	

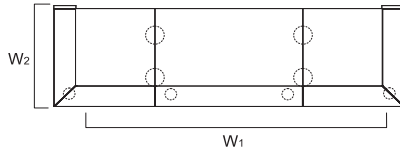
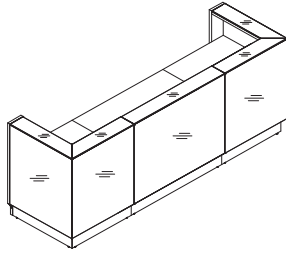

2xLN91+LN12+LNB13+2xLNB08+LN3L+LN3P+2xNL41

INDEX SYMBOL	DIMENSIONS / ABMESSUNGEN [mm]					GBP				COMMENTS / BEMERKUNGEN / REMARQUES
	W ₁	W ₂	D ₁	D ₂	H		kg	m ³	pcs	
13 LIN43 08	2844	850	-	-	1105	4 060,-	267.0	2.643	17	

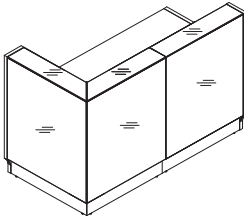

A

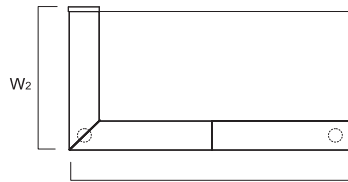

B

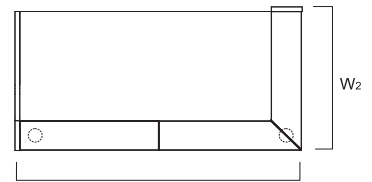

A: LN3P+LN91+LNB15+LN08+LN5L

B: LN5P+LN08+LNB15+LN91+LN3L

INDEX SYMBOL		DIMENSIONS / ABMESSUNGEN [mm]					GBP				COMMENTS / BEMERKUNGEN / REMARQUES
A	B	W ₁	W ₂	D ₁	D ₂	H		kg	m ³	pcs	
15 LIN37L	15 LIN37P	1650	850	-	-	1105	2 346,-	156.0	1.371	12	

DESCRIPTION / LEGENDE / LÉGENDE:

net weight / Nettogewicht / poids net

volume / Volumen / le volume

number of packages / Stückzahl der Pakete / nombre de colis

RECEPTION DESK SYSTEMS / EMPFANGSTHEKEN-SYSTEME / CONFIGURATIONS DES BANQUES

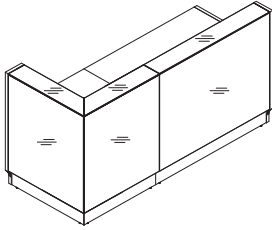

A

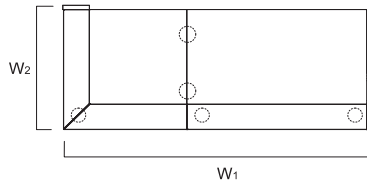

B

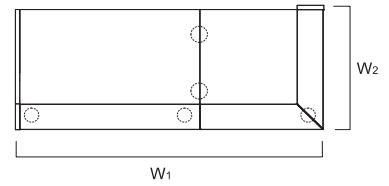

A: LN3P+LN91+LNB08+NL41+LN12+LNB13+LN5L
 B: LN5P+LN12+LNB13+NL41+LNB08+LN91+LN3L

INDEX SYMBOL		DIMENSIONS / ABMESSUNGEN [mm]					GBP	kg	m3	pcs	COMMENTS / BEMERKUNGEN / REMARQUES
A	B	W ₁	W ₂	D ₁	D ₂	H					
¹³ LIN38L	¹³ LIN38P	2050	850	-	-	1105	2 718,-	180.0	1.569	14	

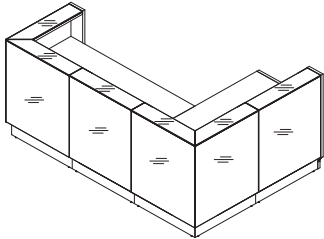

A

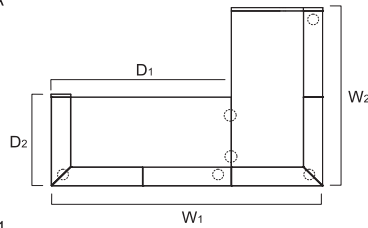

B

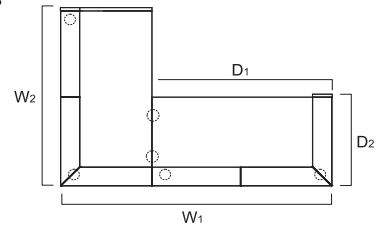

A: LN3P+LN91+LNB15+LN08+LN91+LNB15+LN08+LN5L+NL41
 B: LN5P+LN08+LNB15+LN91+LN08+LNB15+LN91+LN3L+NL41

INDEX SYMBOL		DIMENSIONS / ABMESSUNGEN [mm]					GBP	kg	m3	pcs	COMMENTS / BEMERKUNGEN / REMARQUES
A	B	W ₁	W ₂	D ₁	D ₂	H					
¹⁵ LIN39L	¹⁵ LIN39P	2444	1650	1622	850	1105	4 580,-	296.0	2.764	24	

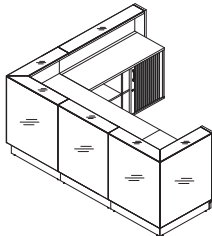

A

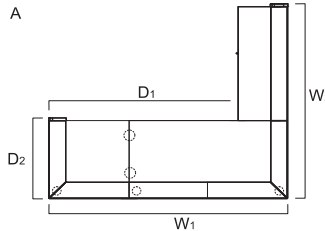

B

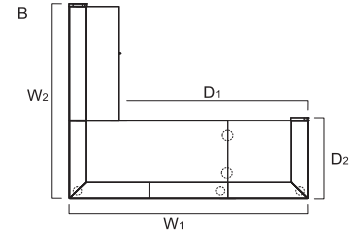

A: LN3P+LN91+LNB08+LNB15+LN08+LN91+NL41+LN12+L2Z06+LN3L
 B: LN3L+L2Z06+LN12+LN91+LN08+LNB15+LNB08+NL41+LN91+LN3P

INDEX SYMBOL		DIMENSIONS / ABMESSUNGEN [mm]					GBP	kg	m3	pcs	COMMENTS / BEMERKUNGEN / REMARQUES
A	B	W ₁	W ₂	D ₁	D ₂	H					
⁰⁸ LIN40L	¹⁵ LIN40P	2444	2050	1950	850	1105	5 131,-	336.5	3.301	24	

DESCRIPTION / LEGENDE / LÉGENDE:

net weight / Nettogewicht / poids net

volume / Volumen / le volume

number of packages / Stückzahl der Pakete / nombre de colis

RECEPTION DESK SYSTEMS / EMPFANGSTHEKEN-SYSTEME / CONFIGURATIONS DES BANQUES

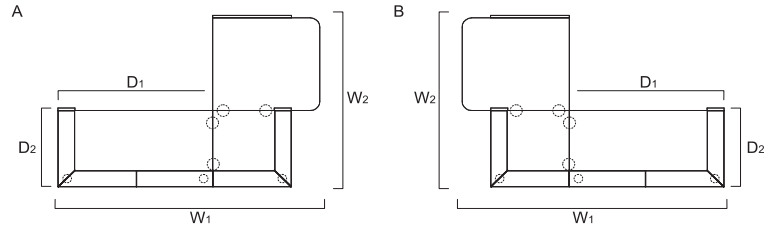
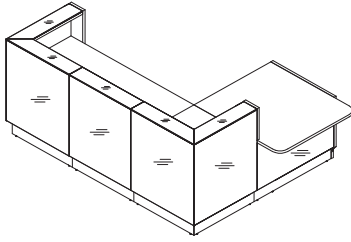

A: LN3P+LN91+LNB15+LN08+NL41+LN91+NL41+LNB08+LNU11+LN4L+LN6L
 B: LN6P+LNU11+LN4P+LNB08+NL41+LN91+NL41+LN08+LNB15+LN91+LN3L



INDEX SYMBOL		DIMENSIONS / ABMESSUNGEN [mm]					GBP	kg	m ³	pcs	COMMENTS / BEMERKUNGEN / REMARQUES
A	B	W ₁	W ₂	D ₁	D ₂	H					
¹⁵ LIN41L ⁰⁸	¹⁵ LIN41P ⁰⁸	2744	1850	1622	850	1105	4 536,-	286.5	2.692	24	

DESCRIPTION / LEGENDE / LÉGENDE:





net weight / Nettogewicht / poids net

volume / Volumen / le volume

number of packages / Stückzahl der Pakete / nombre de colis

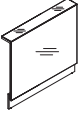
PRODUCT ILLUSTRATION / PRODUKTANSICHT UND SKIZZE / VUE DE PRODUIT	DIMENSIONS / ABMESSUNGEN [mm]			INDEX SYMBOL	PRICE GBP					COMMENTS / BEMERKUNGEN / REMARQUES
	WIDTH / BREITE / LARGEUR	DEPTH / TIEFE / PROFONDEUR	HEIGHT / HÖHE / HAUTEUR			kg	m3	pcs		

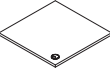
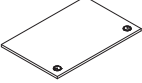
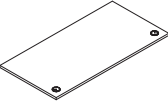
ELEMENTS / BAUTEILE / ÉLÉMENTS COMPOSANTS

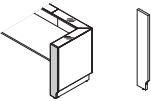
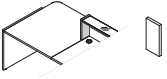
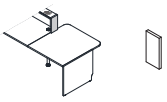

	800	250	1105	LN08	990,-	28.5	0.259	4		
	1200	250	1105	LN12	1 350,-	42.5	0.380	4		
	822	822	1105	LN91	1 500,-	79.5	1.011	4		
	1000	1122	740	LNU11	900,-	32.5	0.161	4		
	800	800	28	LNB08	60,-	14.0	0.025	1		
	1200	800	28	LNB13	77,-	21.0	0.042	2		
	1600	800	28	LNB15	94,-	27.0	0.054	2		
	254	28	1105	LN3L	70,-	7.0	0.014	1		-left / -links / -gauche
	254	28	1105	LN3P	70,-	7.0	0.014	1		-right / -rechts / -droit
	254	28	367	LN4L	60,-	2.5	0.006	1		-left / -links / -gauche
	254	28	367	LN4P	60,-	2.5	0.006	1		-right / -rechts / -droit

DESCRIPTION / LEGENDE / LÉGENDE:





 net weight / Nettogewicht / poids net

 volume / Volumen / le volume

 number of packages / Stückzahl der Pakete / nombre de colis

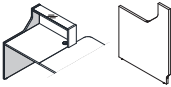
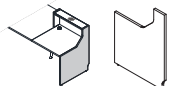
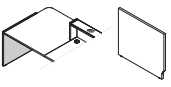
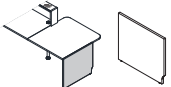
PRODUCT ILLUSTRATION / PRODUKTANSICHT UND SKIZZE / VUE DE PRODUIT	DIMENSIONS / ABMESSUNGEN [mm]			INDEX SYMBOL	PRICE GBP					COMMENTS / BEMERKUNGEN / REMARQUES
	WIDTH / BREITE / LARGEUR	DEPTH / TIEFE / PROFONDEUR	HEIGHT / HÖHE / HAUTEUR			kg	m3	pcs		

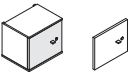
ELEMENTS / BAUTEILE / ÉLÉMENTS COMPOSANTS

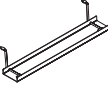
	824	28	1105	LN5L	90,-	14.0	0.033	1		-left / -links / -gauche
	824	28	1105	LN5P	90,-	14.0	0.033	1		-right / -rechts / -droit
	824	28	740	LN6L	68,-	12.0	0.024	1		-left / -links / -gauche
	824	28	740	LN6P	68,-	12.0	0.022	1		-right / -rechts / -droit
	345	283	314	LMS05	145,-	5.0	0.031	1		
	339	18	286	LMS06	47,-	2.0	0.005	1		
	1200	532	740	L2Z06	296,-	49.5	0.469	2		
	585	142	690	NL41	24,-	2.0	0.063	1		
	460	70	87	E64	27,-	0.0	0.000	0		horizontal cable tray 09-aluminum / Kabelkanal 09 - Aluminium / bac à câble - 09 aluminium

DESCRIPTION / LEGENDE / LÉGENDE:

 net weight / Nettogewicht / poids net

 volume / Volumen / le volume

 number of packages / Stückzahl der Pakete / nombre de colis