

TECHNICAL SPECIFICATION / TECHNISCHE BESCHREIBUNG / DESCRIPTION TECHNIQUE

**Glass top
Glasplatte
Top verre**

OPTIWHITE Glass painted on the underside
Glas OPTIWHITE von unten bemalt
Verre OPTIWHITE laque d'en-dessous
8mm

**Worktop
Arbeitsplatte
Plan de travail**

MFC / Melaminplatte /
Panneau mélaminé
28mm

Front / Front / Façade

Powder-coated metal
element with plexiglass
Metall pulverbeschichtet , Plexiglas
Éléments en plexiglass dans l'habillage
en acier peint en poudre

**Illumination
Beleuchtung
Illumination**

RGBW LED

**Lower side panel
Wangenfuß niedrig
Pied bas**

MFC / Melaminplatte /
Panneau mélaminé
28mm

**Level adjusters
Bodenausgleich
Vérins de réglage**

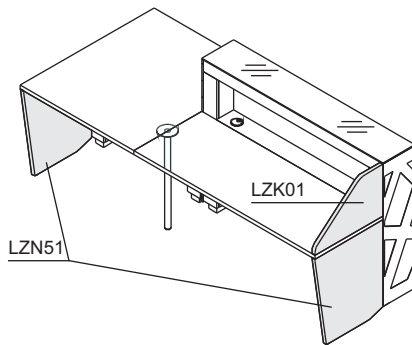
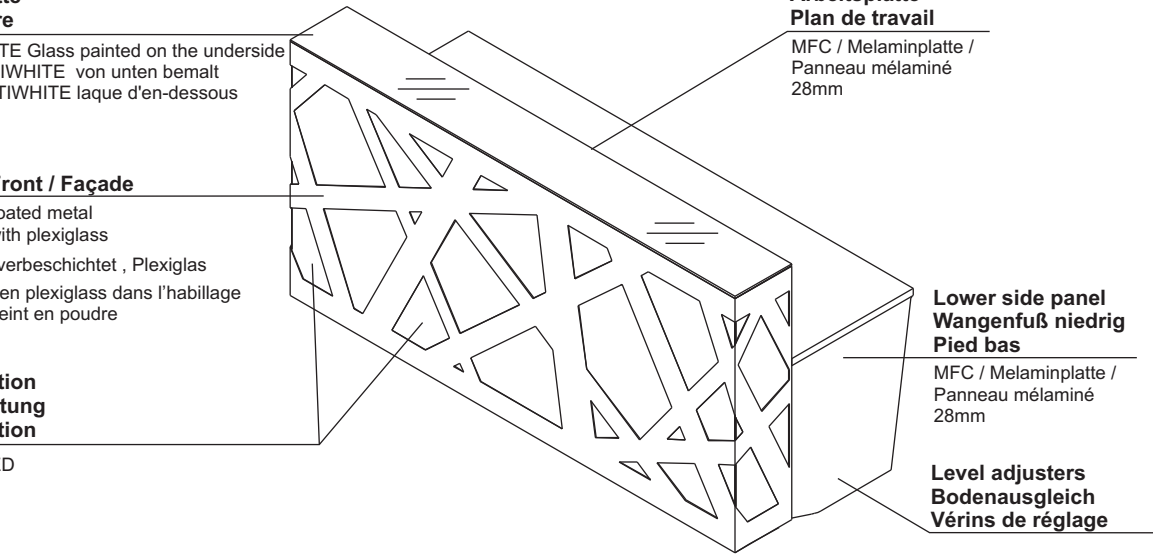

**Cable-way
Kabeldurchlass
Obturateur**
Ø 80mm

**Supporting leg where worktops connect
Stützfuß
Nécessaire sur la jonction des banquettes**

NE41 required on all connections of receptions /
NE41 Stützfuß zusätzlich zur Verbindung der
Thekenelemente bestellen /
NE41 nécessaire sur la connexion des banquettes
15 - METAL, HIGH GLOSS WHITE
15 - METALL, WEIß GLANZ
15 - METAL, BLANC BRILLANT

**Upper side panel
Endungselement
Panneau latéral**

MFC / Melaminplatte /
Panneau mélaminé
28mm

DIMENSIONS / ABMESSUNGEN / DIMENSIONS

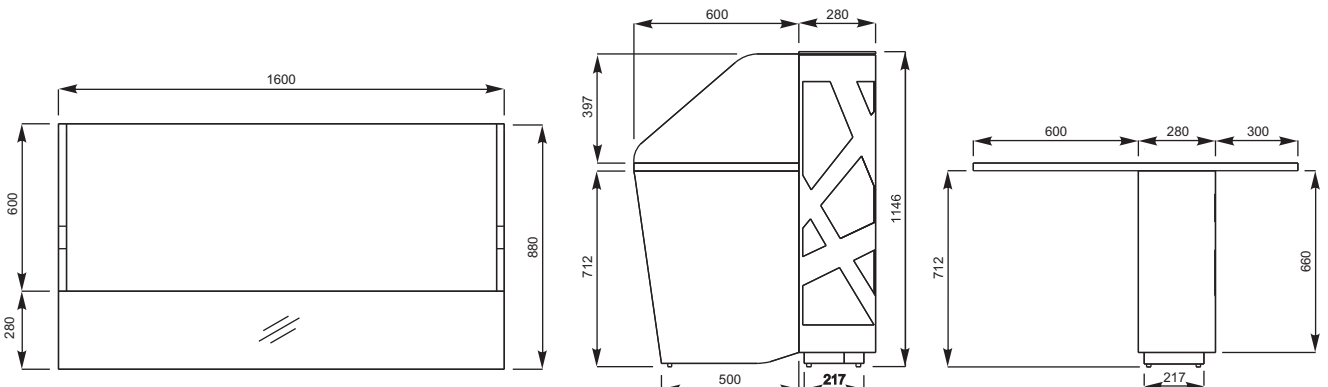

FINISHES / FARBEN / FINITIONS

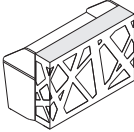
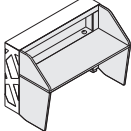
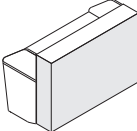
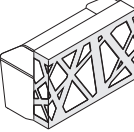
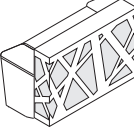
<p>TEMPERED GLASS, WHITE HARTGLAS, WEIß VERRE TREMPÉ, BLANC</p>		
<p>67 WHITE PASTEL WEIß PASTELL BLANC PASTEL</p>		
<p>15 WHITE METAL WEIß METAL BLANC</p>		
<p>PLEXIGLASS WHITE PLEXIGLAS WEIß PLEXIGLASS BLANC</p>		

RECEPTION DESK SYSTEMS / EMPFANGSTHEKEN-SYSTEME / CONFIGURATIONS DES BANQUES

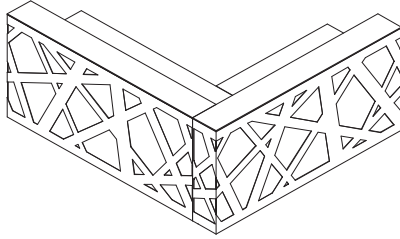

LZN51+LZG22+LZB22+NE41+LZG22+LZB22M

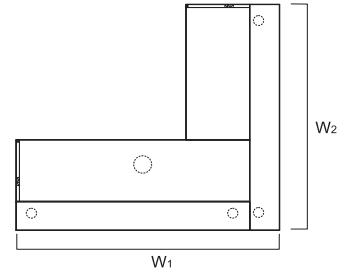

INDEX SYMBOL	DIMENSIONS / ABMESSUNGEN [mm]					GBP				COMMENTS / BEMERKUNGEN / REMARQUES
	W ₁	W ₂	D ₁	D ₂	H		kg	m ³	pcs	
LZG44	2480	2200	-	-	1146	6 939,-	293.7	3.186	18	

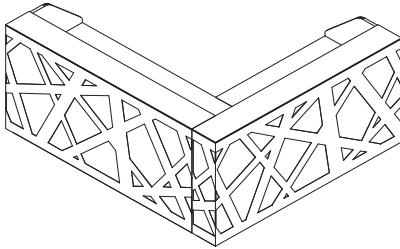

LZK01+LZN51+LZG22+LZB22+NE41+LZG22+LZB22M

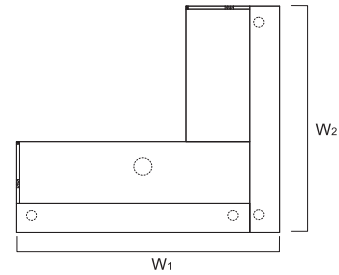

INDEX SYMBOL	DIMENSIONS / ABMESSUNGEN [mm]					GBP				COMMENTS / BEMERKUNGEN / REMARQUES
	W ₁	W ₂	D ₁	D ₂	H		kg	m ³	pcs	
LZG45	2480	2200	-	-	1146	6 998,-	300.7	3.206	19	

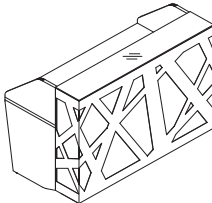

LZ034 - LZK01+LZN51+LZG16+LZB16
LZ046 - LZK01+LZN51+LZG22+LZB22+NE41

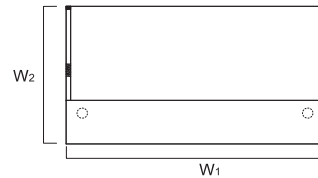

INDEX SYMBOL	DIMENSIONS / ABMESSUNGEN [mm]					GBP				COMMENTS / BEMERKUNGEN / REMARQUES
	W ₁	W ₂	D ₁	D ₂	H		kg	m ³	pcs	
LZG34	1600	880	-	-	1146	2 805,-	131.9	1.250	9	
LZG46	2200	880	-	-	1146	3 594,-	165.4	1.648	10	

DESCRIPTION / LEGENDE / LÉGENDE:

net weight / Nettogewicht / poids net

volume / Volumen / le volume

number of packages / Stückzahl der Pakete / nombre de colis

RECEPTION DESK SYSTEMS / EMPFANGSTHEKEN-SYSTEME / CONFIGURATIONS DES BANQUES

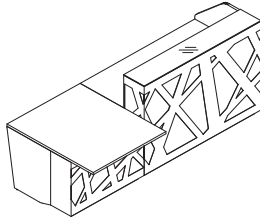

1xNE41 16 16
LZN51+LZG10+2xNE41+LZG22+LZB22+LZK01

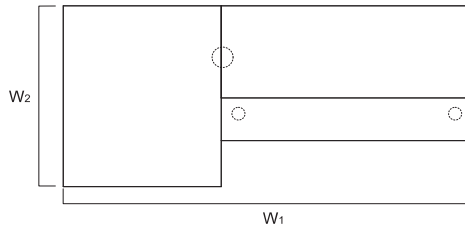

INDEX SYMBOL	DIMENSIONS / ABMESSUNGEN [mm]					GBP				COMMENTS / BEMERKUNGEN / REMARQUES
	W ₁	W ₂	D ₁	D ₂	H		kg	m ³	pcs	
LZG50	2600	1180	-	-	1146	4 465,-	218.4	1.822	15	
LZG51	3200	1180	-	-	1146	5 254,-	250.4	2.203	15	

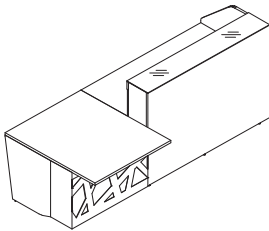

LZB16+LZG16M+LZG10+LZN51+LZK01+NE41

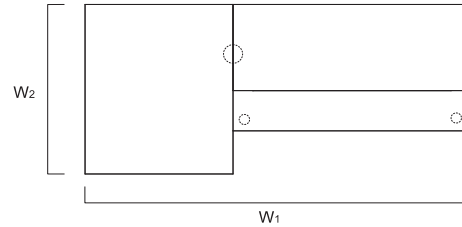

INDEX SYMBOL	DIMENSIONS / ABMESSUNGEN [mm]					GBP				COMMENTS / BEMERKUNGEN / REMARQUES
	W ₁	W ₂	D ₁	D ₂	H		kg	m ³	pcs	
LZG56	2600	1180	-	-	1146	2 616,-	220.4	1.822	15	

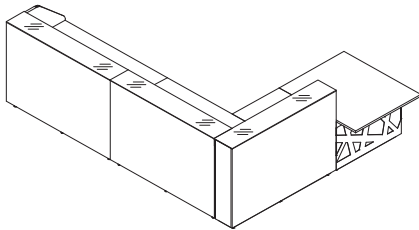

3xLZG16M+LZG10+LZK01+LZN51+LZB16M+2xLZB16+3xNE41

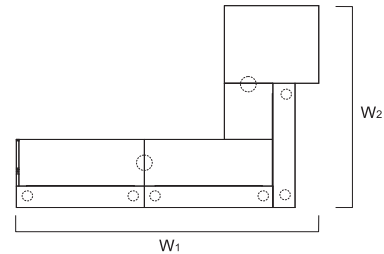

INDEX SYMBOL	DIMENSIONS / ABMESSUNGEN [mm]					GBP				COMMENTS / BEMERKUNGEN / REMARQUES
	W ₁	W ₂	D ₁	D ₂	H		kg	m ³	pcs	
LZG57	3200	2880	-	-	1146	4 283,-	439.2	4.215	31	

DESCRIPTION / LEGENDE / LÉGENDE:

net weight / Nettogewicht / poids net

volume / Volumen / le volume

number of packages / Stückzahl der Pakete / nombre de colis

RECEPTION DESK SYSTEMS / EMPFANGSTHEKEN-SYSTEME / CONFIGURATIONS DES BANQUES

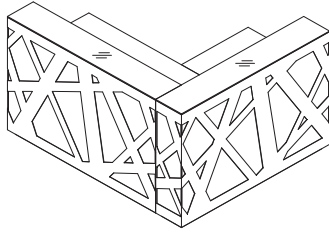

LZN51+LZG16W+LZB16+LZG16+LZB16M

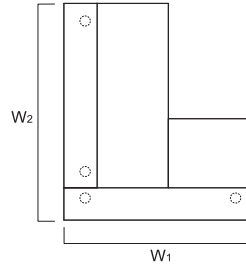

INDEX SYMBOL	DIMENSIONS / ABMESSUNGEN [mm]					GBP				COMMENTS / BEMERKUNGEN / REMARQUES
	W ₁	W ₂	D ₁	D ₂	H		kg	m ³	pcs	
LZG32	1600	1880	-	-	1146	5 385,-	227.5	2.395	16	

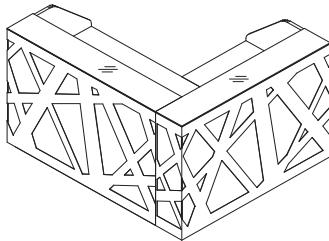

LZK01+LZN51+LZG16+LZB16+LZG16+LZB16M

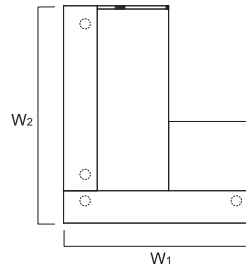

INDEX SYMBOL	DIMENSIONS / ABMESSUNGEN [mm]					GBP				COMMENTS / BEMERKUNGEN / REMARQUES
	W ₁	W ₂	D ₁	D ₂	H		kg	m ³	pcs	
LZG35	1600	1880	-	-	1146	5 444,-	234.5	2.414	17	

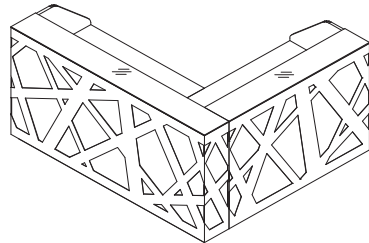

LZK01+LZN51+LZG22+LZB22M+LZG16+LZB16

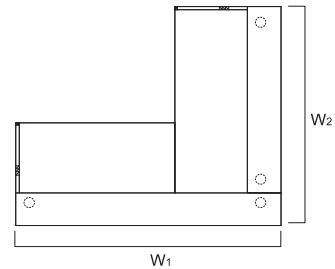

INDEX SYMBOL	DIMENSIONS / ABMESSUNGEN [mm]					GBP				COMMENTS / BEMERKUNGEN / REMARQUES
	W ₁	W ₂	D ₁	D ₂	H		kg	m ³	pcs	
LZG36	2200	1880	-	-	1146	6 209,-	266.5	2.807	17	

DESCRIPTION / LEGENDE / LÉGENDE:

net weight / Nettogewicht / poids net

volume / Volumen / le volume

number of packages / Stückzahl der Pakete / nombre de colis

RECEPTION DESK SYSTEMS / EMPFANGSTHEKEN-SYSTEME / CONFIGURATIONS DES BANQUES

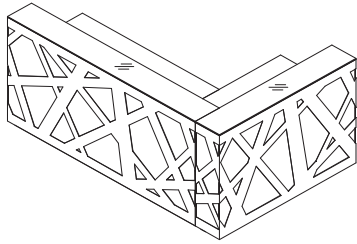

LZN51+LZG22+LZB16+LZG16+LZB22M

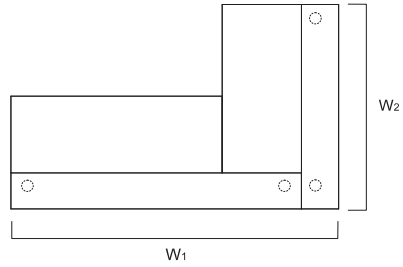

INDEX SYMBOL	DIMENSIONS / ABMESSUNGEN [mm]					GBP				COMMENTS / BEMERKUNGEN / REMARQUES
	W ₁	W ₂	D ₁	D ₂	H		kg	m ³	pcs	
LZG38	2480	1600	-	-	1146	6 150,-	259.5	2.788	16	

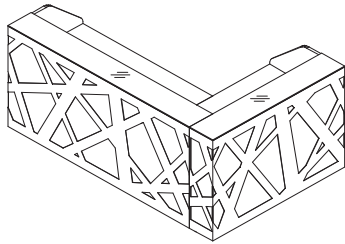

LZK01+LZN51+LZG22+LZB16+LZG16+LZB22M

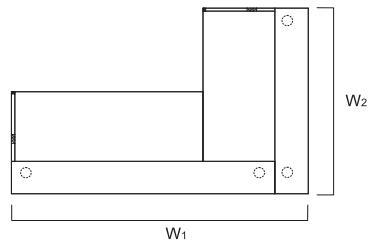

INDEX SYMBOL	DIMENSIONS / ABMESSUNGEN [mm]					GBP				COMMENTS / BEMERKUNGEN / REMARQUES
	W ₁	W ₂	D ₁	D ₂	H		kg	m ³	pcs	
LZG40	2480	1600	-	-	1146	6 209,-	266.5	2.807	17	

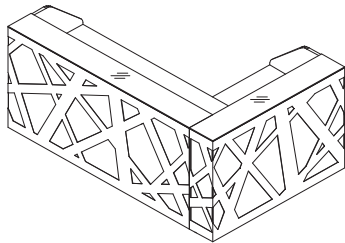

LZK01+LZN51+LZG22+LZB22+NE41+LZG16+LZB16M

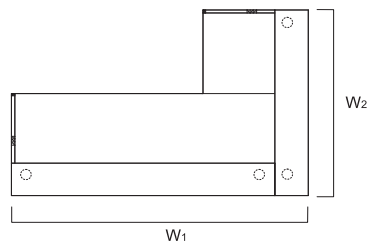

INDEX SYMBOL	DIMENSIONS / ABMESSUNGEN [mm]					GBP				COMMENTS / BEMERKUNGEN / REMARQUES
	W ₁	W ₂	D ₁	D ₂	H		kg	m ³	pcs	
LZG42	2480	1600	-	-	1146	6 233,-	265.9	2.811	15	

DESCRIPTION / LEGENDE / LÉGENDE:

net weight / Nettogewicht / poids net

volume / Volumen / le volume

number of packages / Stückzahl der Pakete / nombre de colis

RECEPTION DESK SYSTEMS / EMPFANGSTHEKEN-SYSTEME / CONFIGURATIONS DES BANQUES

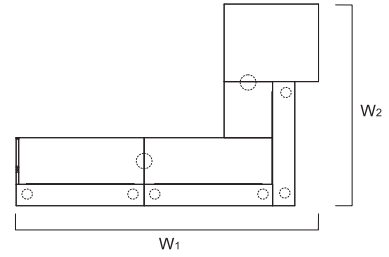
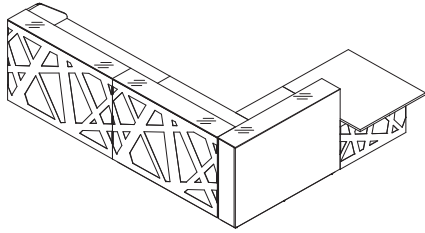

LZG16M+2xLZG16+LZG10+LZK01+LZN51+LZB16M+2xLZB16+3xNE41

INDEX SYMBOL	DIMENSIONS / ABMESSUNGEN [mm]					GBP				COMMENTS / BEMERKUNGEN / REMARQUES
	W ₁	W ₂	D ₁	D ₂	H		kg	m ³	pcs	
LZG58	3808	2880	-	-	1146	7 981,-	435.2	4.215	31	

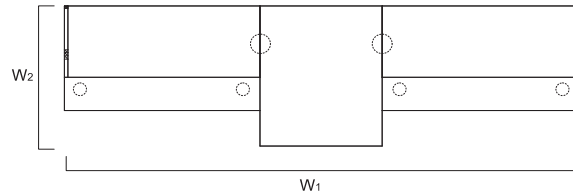
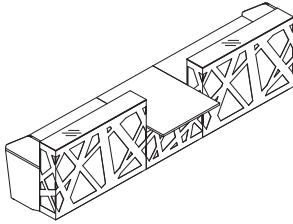

¹⁶ ¹⁶ 2xNE41 ¹⁶ ¹⁶
₁₆ ₁₆ 3xNE41 ₂₂ ₂₂
LZN51+LZG22+LZB22+4xNE41+LZG10+LZG22+LZB22+LZK01

INDEX SYMBOL	DIMENSIONS / ABMESSUNGEN [mm]					GBP				COMMENTS / BEMERKUNGEN / REMARQUES
	W ₁	W ₂	D ₁	D ₂	H		kg	m ³	pcs	
LZG52	4200	1180	-	-	1146	7 166,-	329.8	3.034	23	
LZG53	4800	1180	-	-	1146	7 955,-	363.3	3.433	24	
LZG54	5400	1180	-	-	1146	8 744,-	396.8	3.831	25	

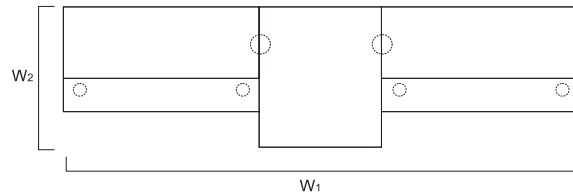
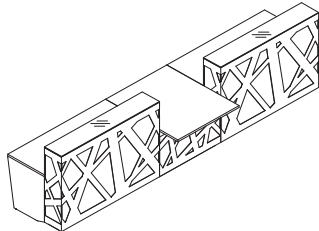

LZN51+LZG16+LZB16+NE41+LZG10+NE41+LZG16+LZB16

INDEX SYMBOL	DIMENSIONS / ABMESSUNGEN [mm]					GBP				COMMENTS / BEMERKUNGEN / REMARQUES
	W ₁	W ₂	D ₁	D ₂	H		kg	m ³	pcs	
LZG55	4200	1180	-	-	1146	7 107,-	322.8	3.015	22	

DESCRIPTION / LEGENDE / LÉGENDE:

net weight / Nettogewicht / poids net

volume / Volumen / le volume

number of packages / Stückzahl der Pakete / nombre de colis

RECEPTION DESK SYSTEMS / EMPFANGSTHEKEN-SYSTEME / CONFIGURATIONS DES BANQUES

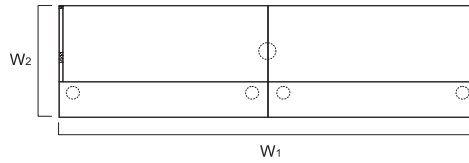
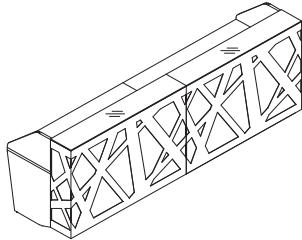

16 16 1xNE41 16 16
16 16 2xNE41 22 22
LZK01+LZN51+LZG22+LZB22+3xNE41+LZG22+LZB22

INDEX SYMBOL	DIMENSIONS / ABMESSUNGEN [mm]					GBP				COMMENTS / BEMERKUNGEN / REMARQUES
	W ₁	W ₂	D ₁	D ₂	H		kg	m ³	pcs	
LZG60	3200	880	-	-	1146	5 506,-	243.3	2.462	17	
LZG61	3800	880	-	-	1146	6 295,-	276.8	2.860	18	
LZG62	4400	880	-	-	1146	7 084,-	310.3	3.258	19	

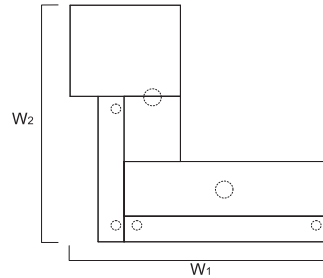
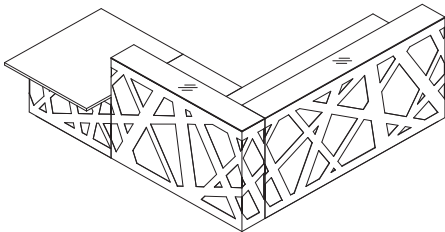

LZN51+LZG10+NE41+LZG16+LZB16M+LZG22+LZB22+NE41

INDEX SYMBOL	DIMENSIONS / ABMESSUNGEN [mm]					GBP				COMMENTS / BEMERKUNGEN / REMARQUES
	W ₁	W ₂	D ₁	D ₂	H		kg	m ³	pcs	
LZG64	2600	2780	-	-	1146	7 834,-	346.8	3.365	22	

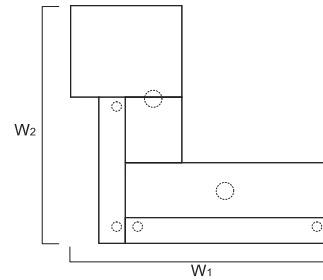
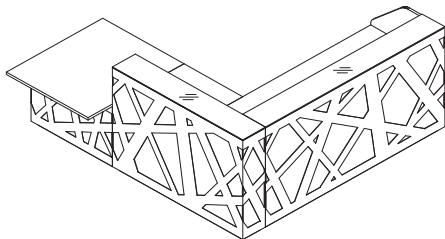

LZN51+LZG10+NE41+LZG16+LZB16M+LZG22+LZB22+NE41+LZK01



INDEX SYMBOL	DIMENSIONS / ABMESSUNGEN [mm]					GBP				COMMENTS / BEMERKUNGEN / REMARQUES
	W ₁	W ₂	D ₁	D ₂	H		kg	m ³	pcs	
LZG63	2600	2780	-	-	1146	7 893,-	353.8	3.384	23	

DESCRIPTION / LEGENDE / LÉGENDE:









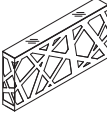

net weight / Nettogewicht / poids net

volume / Volumen / le volume

number of packages / Stückzahl der Pakete / nombre de colis

PRODUCT ILLUSTRATION / PRODUKTANSICHT UND SKIZZE / VUE DE PRODUIT	DIMENSIONS / ABMESSUNGEN [mm]			INDEX SYMBOL	PRICE GBP				COMMENTS / BEMERKUNGEN / REMARQUES
	WIDTH / BREITE / LARGEUR	DEPTH / TIEFE / PROFONDEUR	HEIGHT / HÖHE / HAUTEUR			kg	m ³	pcs	

ELEMENTS / BAUTEILE / ÉLÉMENTS COMPOSANTS



	1600	280	1146	LZG16M	757,-	93.5	1.147	4	
	1600	280	1146	LZG16	2 605,-	91.5	1.147	4	
	2200	280	1146	LZG22	3 345,-	116.5	1.527	4	
	1000	1180	740	LZG10	1 636,-	85.0	0.555	5	
	720	600	28	LZB16M	34,-	10.4	0.017	3	
	1320	600	28	LZB22M	60,-	18.1	0.031	4	
	1600	600	28	LZB16	72,-	18.4	0.049	3	
	2200	600	28	LZB22	98,-	25.4	0.050	3	
	600	28	397	LZK01	60,-	7.0	0.020	1	
	600	28	712	LZN51	68,-	15.0	0.035	1	
	40	40	712	NE41	24,-	1.5	0.017	1	straight leg / Rundfuß / pied tube

DESCRIPTION / LEGENDE / LÉGENDE:

 net weight / Nettogewicht / poids net

 volume / Volumen / le volume

 number of packages / Stückzahl der Pakete / nombre de colis

PRODUCT ILLUSTRATION / PRODUKTANSICHT UND SKIZZE / VUE DE PRODUIT	DIMENSIONS / ABMESSUNGEN [mm]			INDEX SYMBOL	PRICE GBP				COMMENTS / BEMERKUNGEN / REMARQUES
	WIDTH / BREITE / LARGEUR	DEPTH / TIEFE / PROFONDEUR	HEIGHT / HÖHE / HAUTEUR			kg	m3	pcs	

ELEMENTS / BAUTEILE / ÉLÉMENTS COMPOSANTS

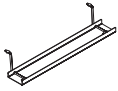
	460	70	87	E64	27,-	0.0	0.000	0	horizontal cable tray 09-aluminum / Kabelkanal 09 - Aluminium / bac à câble - 09 aluminium
---	-----	----	----	------------	------	-----	-------	---	--

DESCRIPTION / LEGENDE / LÉGENDE:

 net weight / Nettogewicht / poids net

 volume / Volumen / le volume

 number of packages / Stückzahl der Pakete / nombre de colis